

# SIDEVIEW

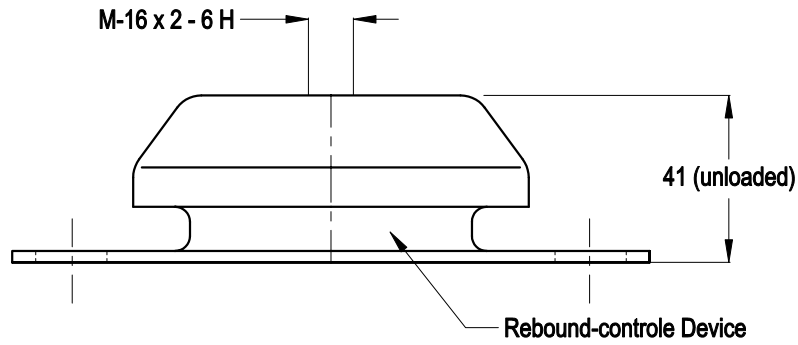

# TOPVIEW

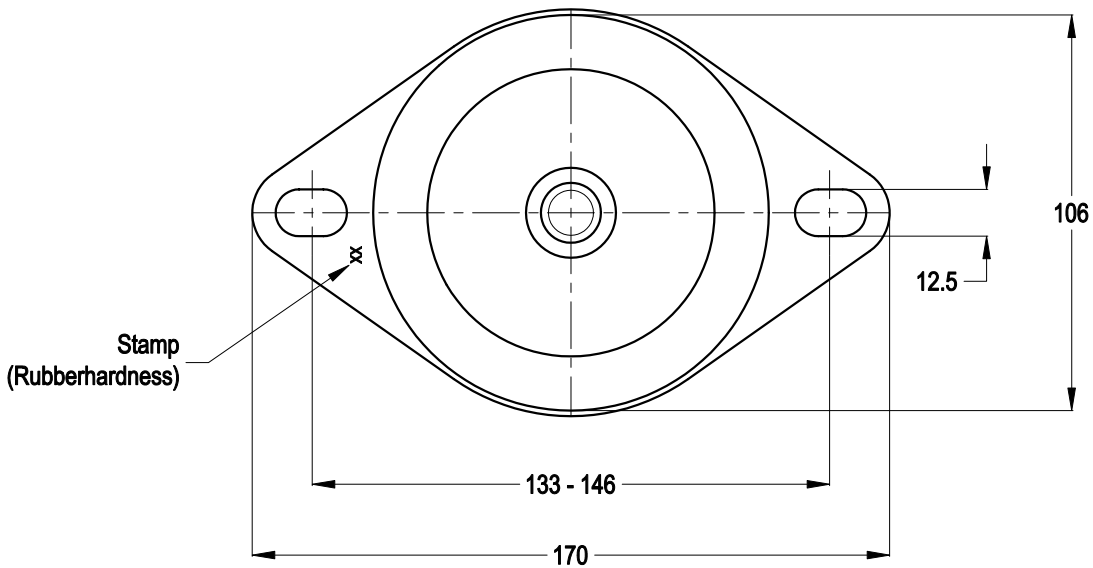

		MATERIAL: METAL/RUBBER		NR. 1	REMARKS: -			
		TITLE: <b>Top Mounting</b>				OVER. TOL. ± 0.5	ANGULARITY ± 0.5	ROUGHNESS 3.2 ✓
		TYPE: <b>100240 serie</b>				ALL RIGHTS STRICTLY PRESERVED. REPRODUCTION OR ISSUE TO THIRD PARTIES IS NOT PERMITTED WITHOUT WRITTEN AUTHORITY OF GUMETA TECHNIEK B.V.		
1		-						
REV.	DATE	REMARKS						
SCALE: N.A.		DIMENSIONS IN MM.		<b>MOTORSTEUNEN.NL</b> <b>ENGINEMOUNTS.NL</b>		PROJECTION: 		FORMAT: A4
DRW.	M.S.	DATE 12/04/12				DRAWING NR. 100240		REV. 0
CHK.	H.K.	DATE 12/04/12						