

SIDEVIEW

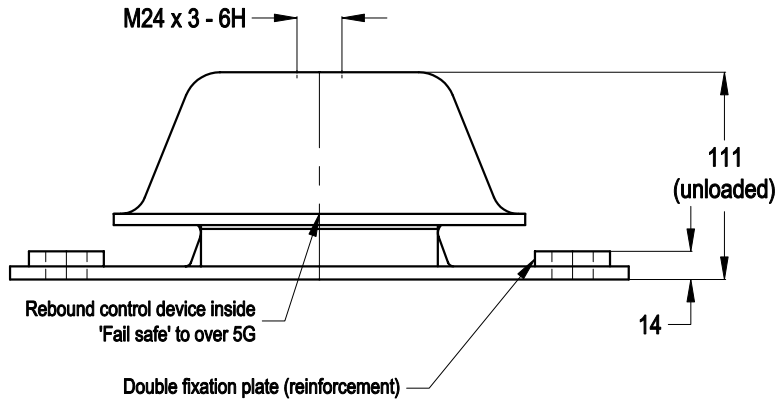

TOPVIEW

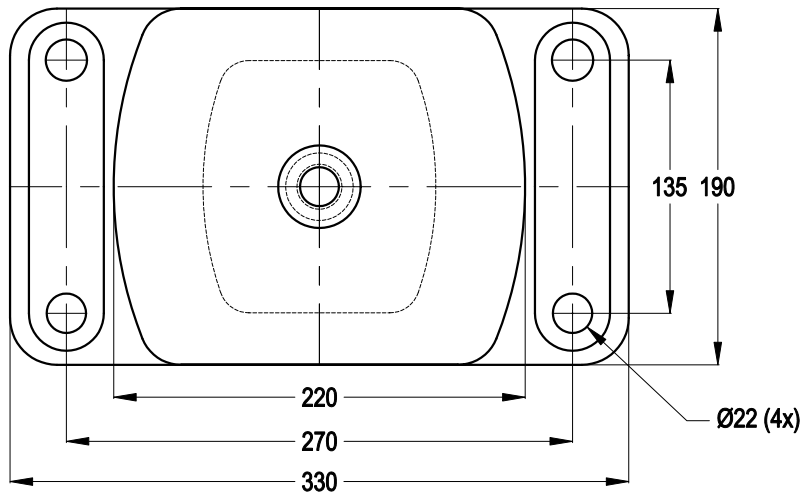

		MATERIAL: METAL/RUBBER		NR. 1	REMARKS: -			
		TITLE: Marine Engine Mounting				OVER. TOL. ± 0.5	ANGULARITY ± 0.5	ROUGHNESS 3.2 ✓
		TYPE: 100050 serie				ALL RIGHTS STRICTLY PRESERVED. REPRODUCTION OR ISSUE TO THIRD PARTIES IS NOT PERMITTED WITHOUT WRITTEN AUTHORITY OF GUMETA TECHNIEK B.V.		
1		-						
REV.	DATE	REMARKS						
SCALE: N.A.		DIMENSIONS IN MM.		MOTORSTEUNEN.NL ENGINEMOUNTS.NL		PROJECTION:		FORMAT: A4
DRW.	M.S.	DATE 06/02/12				DRAWING NR. 100050		REV. 0
CHK.	H.K.	DATE 06/02/12						