

SIDEVIEW

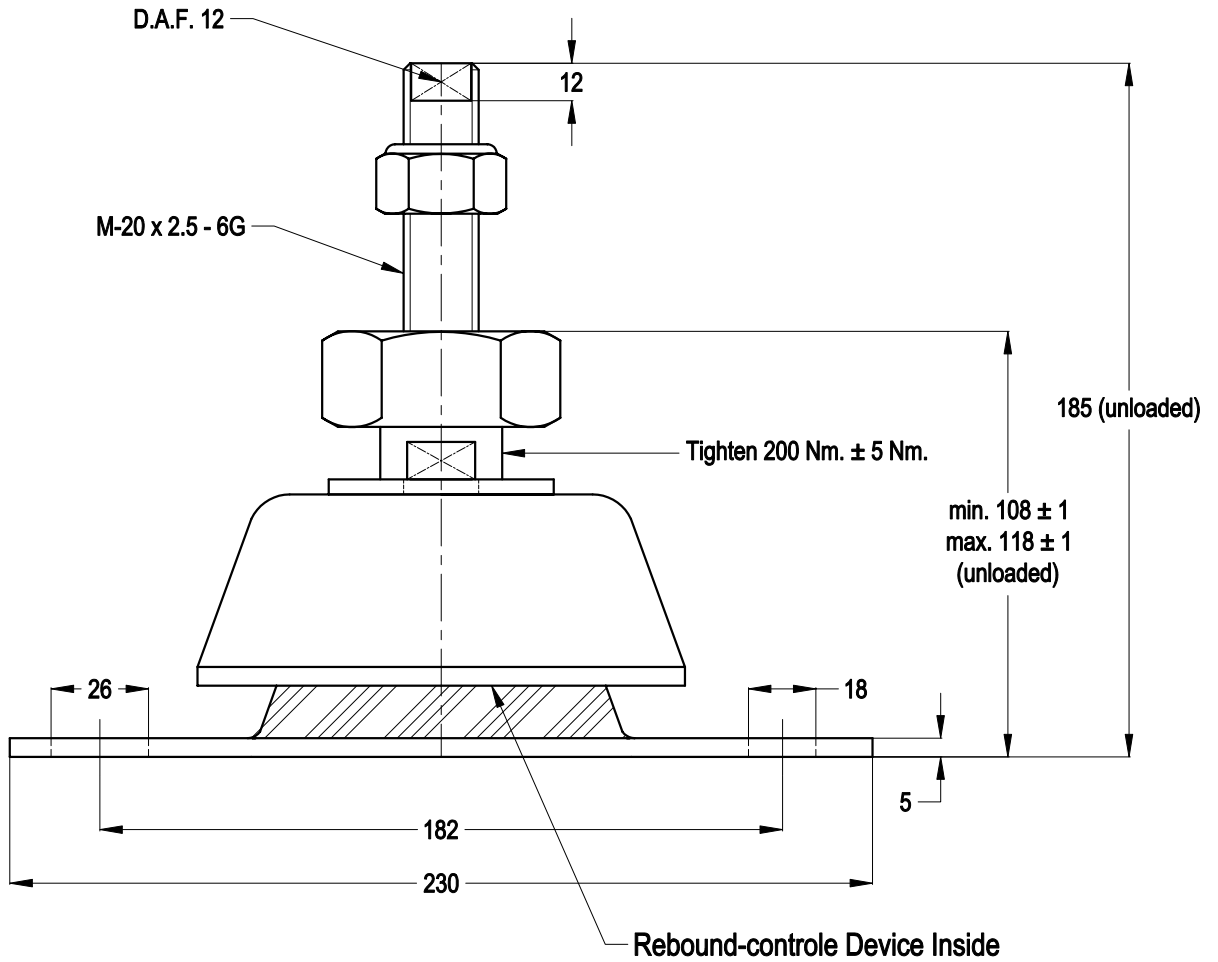

TOPVIEW

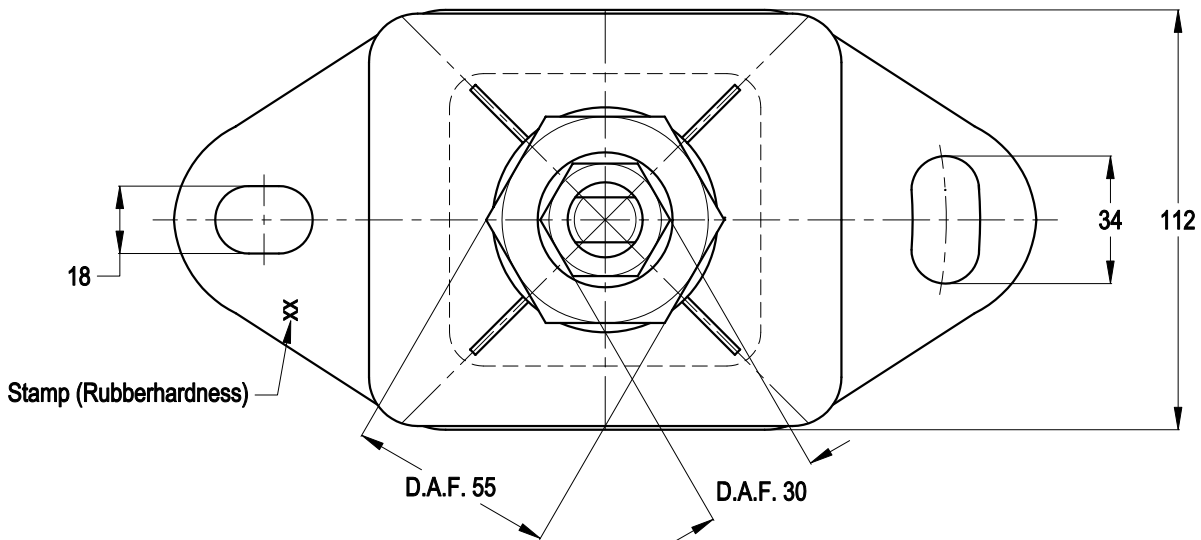

| | | | | | | | |
|------------------------|------|---------------------------------------|--|------------------------|---|---------------------|--------------------|
| | | MATERIAL: METAL/RUBBER | | NR. 1 | REMARKS: - | | |
| | | TITLE: H.A. Marine Engine Mounting | | | OVER. TOL. ± 0.5 | ANGULARITY ± 0.5 | ROUGHNESS 3.2 ✓ |
| | | TYPE: 100042 serie | | | ALL RIGHTS STRICTLY PRESERVED. REPRODUCTION OR ISSUE TO THIRD PARTIES IS NOT PERMITTED WITHOUT WRITTEN AUTHORITY OF GUMETA TECHNIEK B.V. | | |
| REV. | DATE | REMARKS | | | | | |
| 1 | | - | | | | | |
| SCALE: N.A. | | DIMENSIONS IN MM. | | PROJECTION: | | FORMAT: A4 | |
| DRW. M.S. | | DATE 06/02/12 | | DRAWING NR. 100042 | | REV. 0 | |
| CHK. H.K. | | DATE 06/02/12 | | | | | |
| MOTORSTEUNEN.NL | | | | ENGINEMOUNTS.NL | | | |